

Instruction Manual

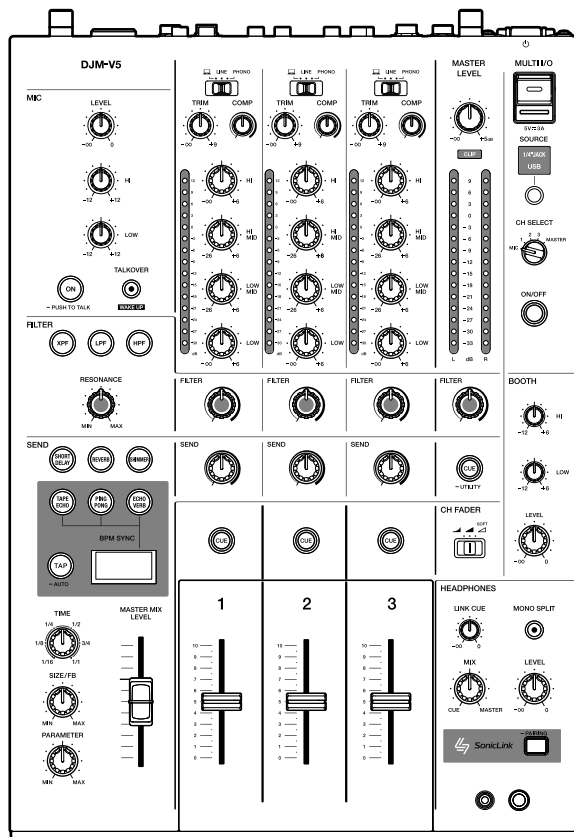

DJ Mixer

DJM-V5

alphatheta.com/support/

rekordbox.com

For FAQ and other support information for this product, visit the websites above.

Contents

Before you start	5
How to read this manual	5
What's in the box.....	5
Installation of supported applications	6
Supported products	7
PRO DJ LINK	8
Part names	9
Top panel	9
Front panel	10
Rear panel.....	11
PC/Mac setup	13
Installation of the dedicated software	13
Setting Utility	15
Connections	21
Connecting to the input terminals.....	22
Connecting to the output terminals	23
Connecting to the terminals on the top panel.....	24
Connecting to the MULTI I/O terminals.....	25
Audio output	26
Channel/master section	26
Outputting sound.....	28
Adjusting the sound.....	29
Setting the fader curves	29
Adjusting the left/right sound balance	29
Monitoring sound	31
Headphones sections.....	31

Monitoring with headphones	32
Monitoring with SonicLink headphones.....	33
Booth section	34
Using a booth monitor	34
Microphone	35
MIC section	35
Using a microphone	36
Filter.....	37
Filter section	37
Using the Filter	38
Send.....	39
Send section	39
Screen	40
Routing effect sounds to the master sound.....	41
Setting the BPM manually.....	42
Send FX and settings.....	43
MULTI I/O.....	45
MULTI I/O section	46
Using MULTI I/O	47
USB/MIDI.....	48
Controlling MIDI software	48
Settings.....	49
Changing the settings	49
Utility settings	50
My Settings	53
Saving My Settings to a storage device	55
Calling up My Settings saved on a storage device	56
Restoring the factory settings.....	57
Specifications	58

Block diagram	63
Additional information	65
Troubleshooting	65
Cleaning	68
Trademarks and registered trademarks	68
Software license notice	69
Cautions on copyrights.....	73

Before you start

How to read this manual

- Thank you for choosing this AlphaTheta product.
Be sure to read this manual, the Quick Start Guide and the Precautions for Use which are also included with this product. These documents include important information that you should understand before using the unit.
- In this manual the names of buttons, knobs and terminals that appear on the product, and the names of buttons, menus etc. in the software on your PC/Mac or mobile device, are indicated within square brackets ([]). (e.g. **[File]**, **[CUE]** button)
- Please note that the software screens and their specifications, as well as the external appearance and specifications of the hardware, are subject to change without notice.
- Please note that depending on the operating system version, web browser settings, etc. operation may differ from the ways described in this manual.
- Please note that the language on the screens of the software described in this manual may differ from the language on your screen.

What's in the box

- Mixer × 1
- Power cord × 1
- Warranty (for some regions)* × 1
- Precautions for Use × 1
- Quick Start Guide × 1

* Only products in Europe and North America.

Products in Japan include warranty information in the Precautions for Use.

Installation of supported applications

❖ rekordbox for Mac/Windows

rekordbox for Mac/Windows is an application that helps DJs manage their music and perform. With the application and this unit, you can DJ using PRO DJ LINK and/or DVS functions. For information on the installation and to access the instruction manual, visit the URL below.

rekordbox.com/

❖ rekordbox for iOS/Android

rekordbox for iOS/Android is a mobile device application that helps DJs manage their music and perform. With the application and this unit, you can DJ using PRO DJ LINK.

To download the application, visit the URL below.

For iOS/iPadOS:

<https://apps.apple.com/us/app/id1487048203>

For Android:

<https://play.google.com/store/apps/details?id=com.pioneerdj.rekordbox>

❖ DJM-REC

DJM-REC is a DJ application that enables easy recording and sharing of mixes for effortless self-promotion to global audiences when you use it on a device connected to a compatible AlphaTheta mixer via a USB cable.

To download the application, visit the URL below.

For iOS/iPadOS:

<https://apps.apple.com/us/app/id1292535659>

- The application isn't available for Android devices.

❖ RMX-1000 for iPad

RMX-1000 for iPad is an application that enables you to perform live remixes with your music.

To download the application, visit the URL below.

For iOS/iPadOS:

<https://apps.apple.com/us/app/id1035498886>

Supported products

You can easily connect the upcoming products below (as of November 2025) with this unit.

- USB-compatible AlphaTheta effects units:
Only USB cables can be used for connection (not analog cables).
- AlphaTheta SonicLink headphones that support near-field communication:
You can pair the headphones by holding them over the reader on the unit.

PRO DJ LINK

You can use PRO DJ LINK functions by connecting the unit via a LAN cable to a PRO DJ LINK compatible multi player or a PC/Mac running rekordbox.

- You can connect up to 3 multi players and up to 2 computers (PC/Mac) to the unit via a switching hub.
- Use a 100BASE-TX compatible switching hub that is supported by multi players. Some switching hubs may not work properly with selected devices.
- Set the multi player number to the channel number which the audio cable is connected to.

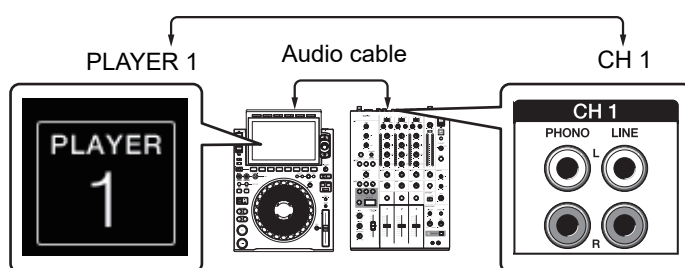

- For details on PRO DJ LINK, see the instruction manuals for the relevant multi players and rekordbox.

alphatheta.com/support/

❖ LINK MONITOR

You can browse and monitor via headphones the sound of tracks in rekordbox for Mac/Windows, or on a multi player, while playing a different track.

⇒ [Monitoring with headphones \(page 32\)](#)

- To monitor the sound of rekordbox for Mac/Windows, switch rekordbox for Mac/Windows to Export mode, click [**Preferences**], then select the [**DJ System**] tab on the left. Open the [**Other**] tab on the upper right and turn on [**Use “LINK MONITOR” of the DJ Mixer**] beforehand.
- You can't monitor the sound of a track from a multi player if the player doesn't support the LINK MONITOR function.

❖ Status Information

You can check on-air information with multi players.

Part names

Top panel

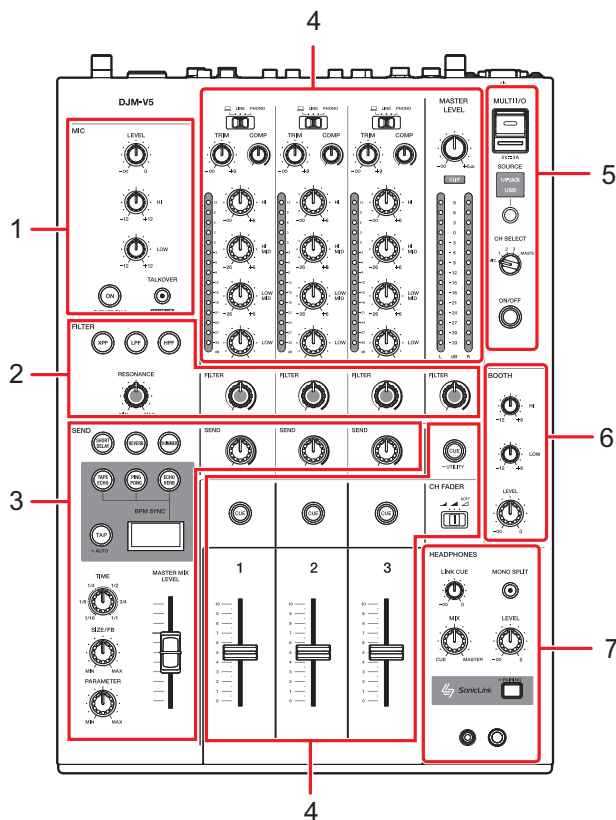

1. **MIC section**
⇒ [MIC section \(page 35\)](#)
2. **Filter section**
⇒ [Filter section \(page 37\)](#)
3. **SEND section**
⇒ [Send section \(page 39\)](#)
4. **Channel/Master section**
⇒ [Channel/master section \(page 26\)](#)
5. **MULTI I/O section**
⇒ [MULTI I/O section \(page 46\)](#)

6. BOOTH section

⇒ [Booth section \(page 34\)](#)

7. HEADPHONES section

⇒ [Headphones sections \(page 31\)](#)

Front panel

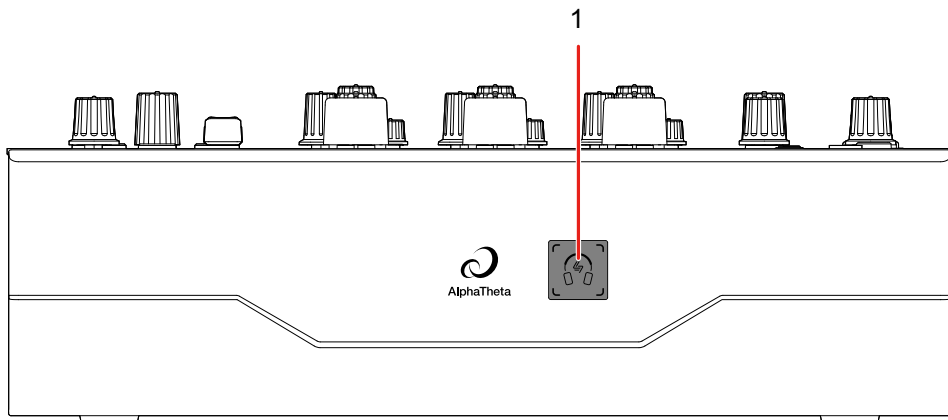

1. Headphones touch area

⇒ [Monitoring with SonicLink headphones \(page 33\)](#)

Rear panel

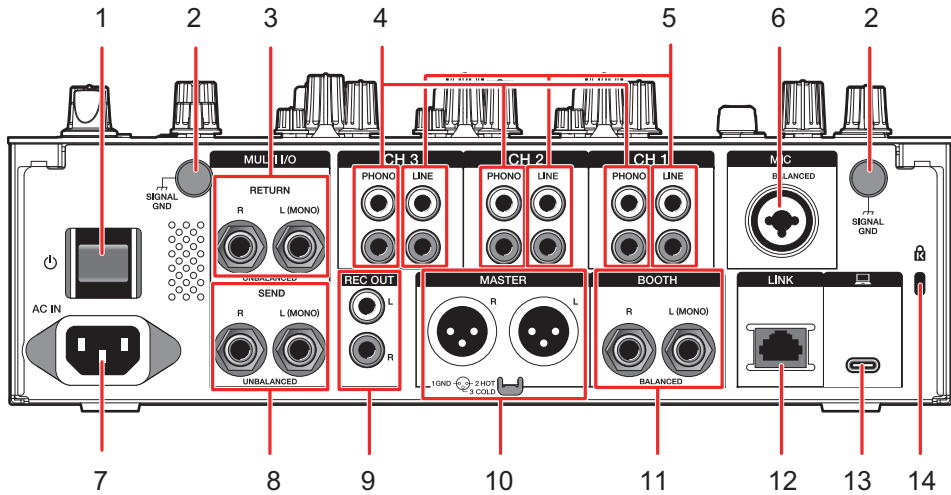

1. button

Turns the unit on and off.

2. **Signal GND terminal**

Connect a turntable's ground wire.

Reduces unwanted noises that occur when a turntable is connected to the unit.

⇒ [Connecting to the input terminals \(page 22\)](#)

3. **MULTI I/O, RETURN terminals (1/4"/6.35 mm, TS)**

Connect to output terminals on external effects units.

- If you connect equipment to the [L (MONO)] terminal only, the sound input to the [L (MONO)] terminal is also input to the [R] channel.

⇒ [Connecting to the MULTI I/O terminals \(page 25\)](#)

4. **PHONO terminals (RCA)**

Connect phono-level (MM cartridge) output devices.

- Do not input line-level signals to the terminals.

⇒ [Connecting to the input terminals \(page 22\)](#)

5. **LINE terminals (RCA)**

Connect multi players or line-level output devices.

⇒ [Connecting to the input terminals \(page 22\)](#)

6. **MIC terminal (XLR or 1/4"/6.35 mm, TRS)**

⇒ [Using a microphone \(page 36\)](#)

7. **AC IN**

Connect to a power outlet with the supplied power cord.

⇒ [Connecting to the input terminals \(page 22\)](#)

8. **MULTI I/O, SEND terminals (1/4"/6.35 mm, TS)**

Connect to input terminals on external effects units.

- If you connect equipment to the [L (MONO)] terminal only, mono sound is output.

⇒ [Connecting to the MULTI I/O terminals \(page 25\)](#)

9. **REC OUT terminals (RCA)**

Connect a device for recording.

- You can use them as output terminals for a power amplifier, etc.

⇒ [Connecting to the output terminals \(page 23\)](#)

10. **MASTER terminals (balanced XLR)**

Connect to analog input terminals on a power amplifier, etc.

- Use the terminals for balanced output only.
- Do not connect a power cord from another product to the terminals.
- Do not connect to a terminal that can supply phantom power.

⇒ [Connecting to the output terminals \(page 23\)](#)

11. **BOOTH terminals (1/4"/6.35 mm, TRS)**

Connect a booth monitor.

- Use the terminals for balanced output only.
- If you connect equipment to the [L (MONO)] terminal only, mono sound is output.

⇒ [Connecting to the output terminals \(page 23\)](#)

12. **LINK terminal**

Connect to a LINK terminal on a PC/Mac running rekordbox or a PRO DJ LINK compatible multi player.

- Use a switching hub (100BASE-T compatible type) to connect multiple devices.

⇒ [Connecting to the input terminals \(page 22\)](#)

13. **USB port**

Connect a PC/Mac.

⇒ [Connecting to the input terminals \(page 22\)](#)

14. **Kensington security slot**

Connect a cable lock.

PC/Mac setup

To input or output your PC/Mac's audio to/from the unit, install the dedicated audio driver software and/or Setting Utility on your PC/Mac.

If you install the dedicated software to your PC (Windows), the Setting Utility and audio driver software will be installed.

If you use a Mac, only the Setting Utility will be installed.

- For information on the latest system requirements, compatibility, and supported operating systems, visit the URL below.

alphatheta.com/support/

- Operation isn't guaranteed on all PC/Mac models, even if the system requirements are met.
- Operation isn't guaranteed when multiple units are connected to a PC/Mac.
- If a PC (Windows) without the audio driver software installed is connected to the unit, errors may occur on the PC.
- Malfunctions may occur due to incompatibility with other software installed on a PC/Mac.

Installation of the dedicated software

❖ Notes on installation

- Turn the unit off and disconnect the USB cable connected to the unit and the PC/Mac before installation.
- Close all applications running on the PC/Mac before installation.
- You'll need admin rights to install the software to your PC/Mac.
- Read the License Agreement terms carefully before installation.
- If you quit the installation halfway through, perform the installation procedure from the beginning again.
- After the installation is complete, connect the PC/Mac to the unit.
- Operation isn't guaranteed on all PC/Mac models.

Downloading the dedicated software

1 Visit the URL below.

alphatheta.com/support/

2 Click [software & firmware updates].

3 Click [DJM-V5] under [DJ MIXER].

4 Click [Drivers].

5 Click [Download link] and save the file.

- Download the software dedicated to your PC/Mac.

Installing the dedicated software

1 Unzip the downloaded dedicated software.

2 Double-click the downloaded installation file.

- Double-click “DJM-V5_#.###.exe” if you’re using a PC (Windows), or “DJM-V5_M_#.###.dmg” → “DJM-V5SettingUtility.pkg” if you’re using a Mac (# indicates the version number of the software).

3 Read the License Agreement terms carefully.

If you agree to the terms, mark the [Agree] check box and click [OK].

- If you don’t agree to the License Agreement terms, click [Disagree] (for Mac)/ [Cancel] (for Windows) to cancel the installation.

4 Follow the on-screen instructions to complete the installation.

Setting Utility

Once you've installed the dedicated software on your PC/Mac, you can use the Setting Utility to check and set connections between the unit and a PC/Mac.

Launching Setting Utility

❖ For Mac

- 1 Open the [Applications] folder in Finder.
- 2 Click [AlphaTheta] → [DJM-V5] → [DJM-V5 Setting Utility].

❖ For PC (Windows 11)

- 1 Open the Start menu and click [All Apps] → [AlphaTheta] → [DJM-V5 Setting Utility].

❖ For PC (Windows 10)

- 1 Open the Start menu and click [AlphaTheta] → [DJM-V5 Setting Utility].

Checking the status of the input selector switches on the unit

1 Click the [MIXER INPUT] tab.

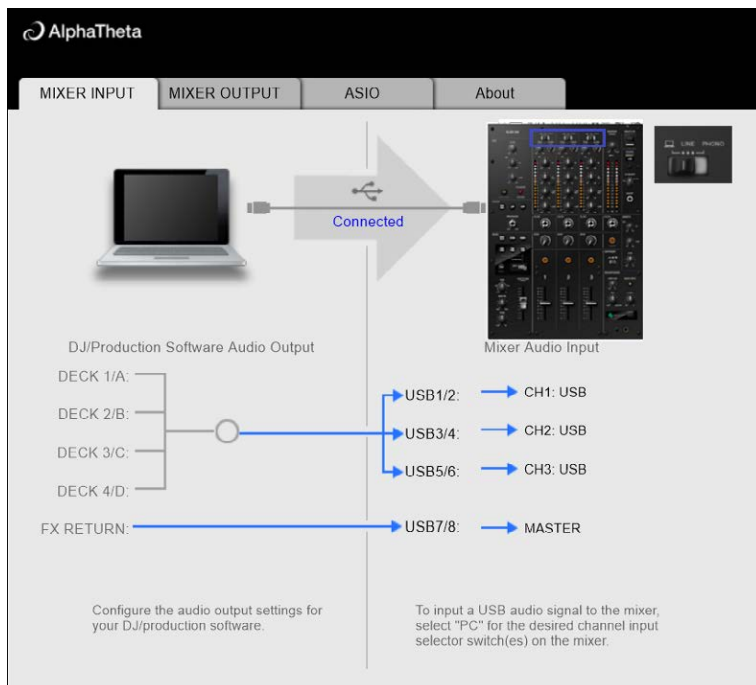

Setting the audio data output from the unit to a PC/Mac

- 1 Click the **[MIXER OUTPUT]** tab.
- 2 Click the pull-down list under **[Mixer Audio Output]** and select the audio data output from the unit to the PC/Mac.

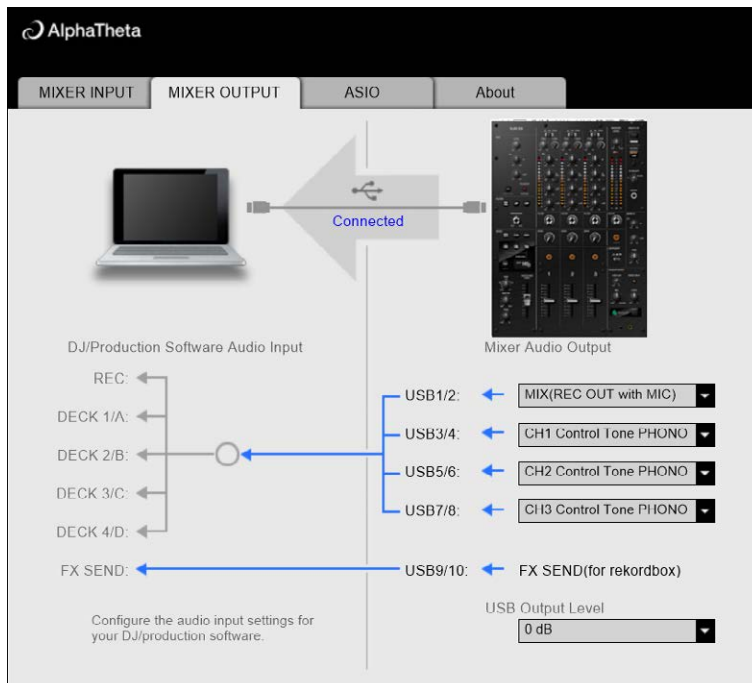

⇒ [Mixer Audio Output pull-down menu \(page 20\)](#)

- 3 Click the pull-down list under **[USB Output Level]** and select a level of volume to output from the unit.

- Set the volume in **[USB Output Level]** when you can't produce as much volume as you expect using the volume adjustment in your DJ application. Note that the sound may be distorted if you set the volume too high.

Adjusting the buffer size (for Windows ASIO)

- Close any running applications (DJ applications, etc.) which use the unit as the default audio device before adjusting the buffer size.

1 Click the [ASIO] tab.

2 Adjust the buffer size with the slider.

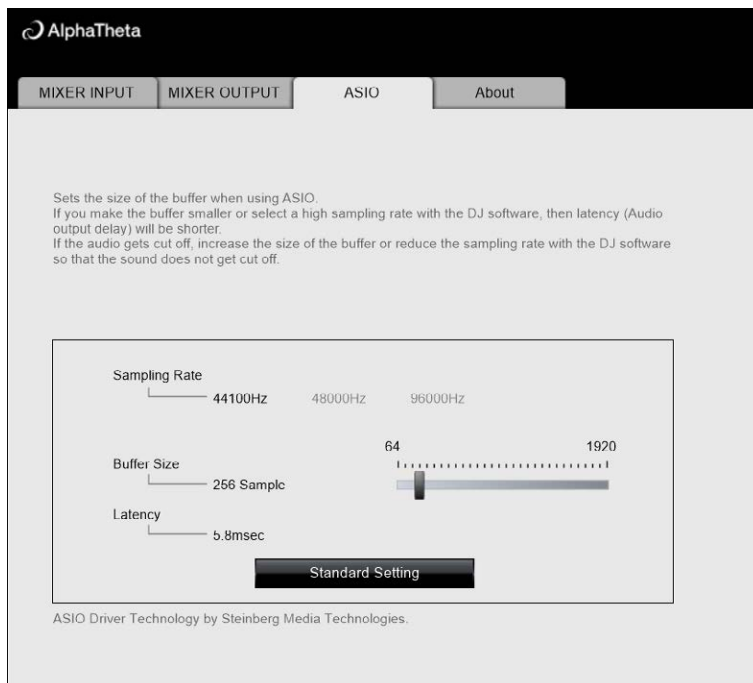

- Breaks in sound are less likely to occur if you set a large buffer size, but this increases lag time due to the latency of audio data transmission.

Checking the firmware and dedicated software versions

1 Click the [About] tab.

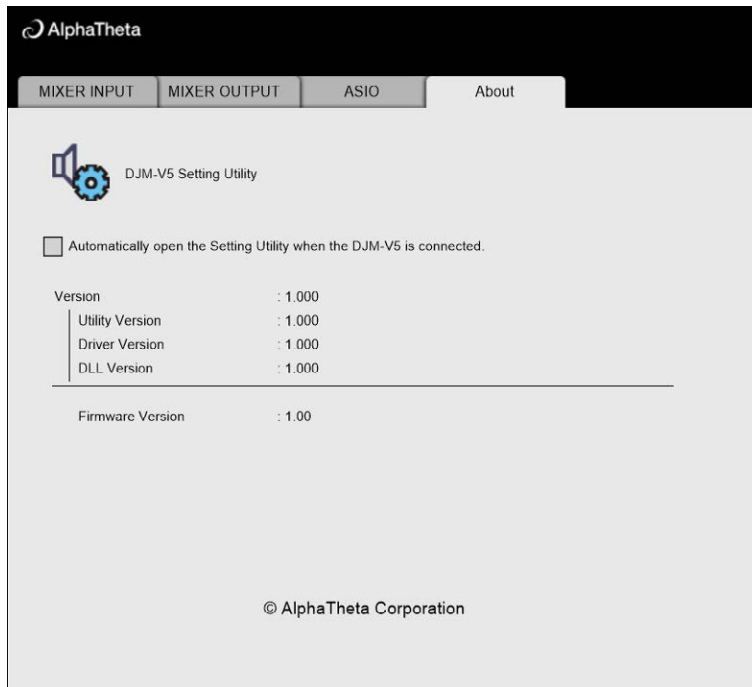

Mixer Audio Output pull-down menu

- USB 9/10 is fixed to **[FX SEND (for rekordbox)]** (available for software applications that support the function).

#: indicates channel number

USB 1/2	USB 3/4, USB 5/6, USB 7/8
MIX (REC OUT with MIC) ^{*1}	CH# Control Tone PHONO ^{*2}
Pre CH1 Fader	CH# Control Tone LINE ^{*2}
Pre CH2 Fader	Pre CH# Fader
Pre CH3 Fader	Post CH# Fader
Post CH1 Fader	MIC
Post CH2 Fader	MIX (REC OUT with MIC) ^{*1}
Post CH3 Fader	MIX (REC OUT without MIC) ^{*1}
MIC	-
MIX (REC OUT without MIC) ^{*1}	-

*1 For uses other than recording, be sure to set the DJ application so that no sound loop occurs. Sound may be input or output at an unintended volume level when a sound loop occurs.

*2 Available for software applications that support the function. Outputs sound at the volume input to the unit regardless of the **[USB Output Level]** setting.

Connections

Turn the unit off and disconnect the power cord before connecting other units.

Connect the power cord after all the connections are complete.

- Use the supplied power cord.
- Read the instruction manuals for the devices you are going to connect with the unit.
- For wired LAN connections, use a Cat5e (or higher) STP cable.
- Do not disconnect a LAN cable when using PRO DJ LINK.

Connecting to the input terminals

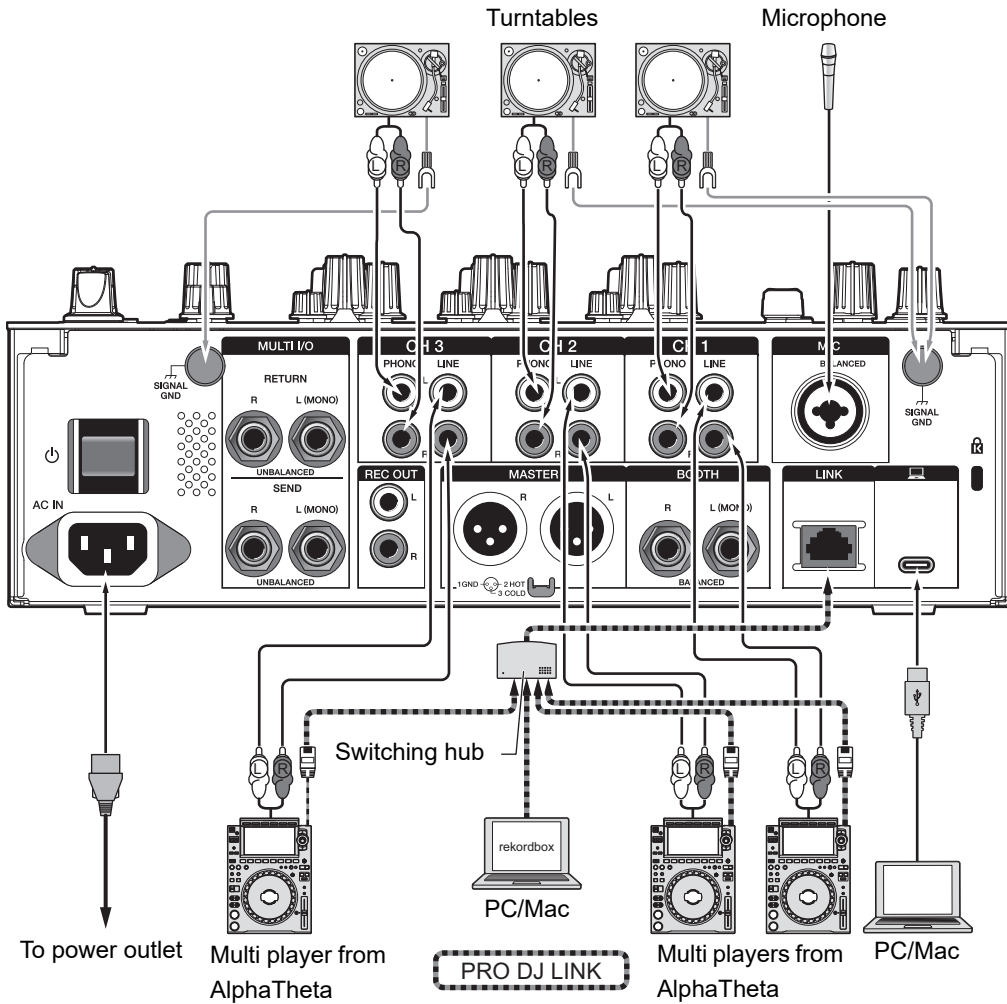

⇒ [PRO DJ LINK \(page 8\)](#)

Connecting to the output terminals

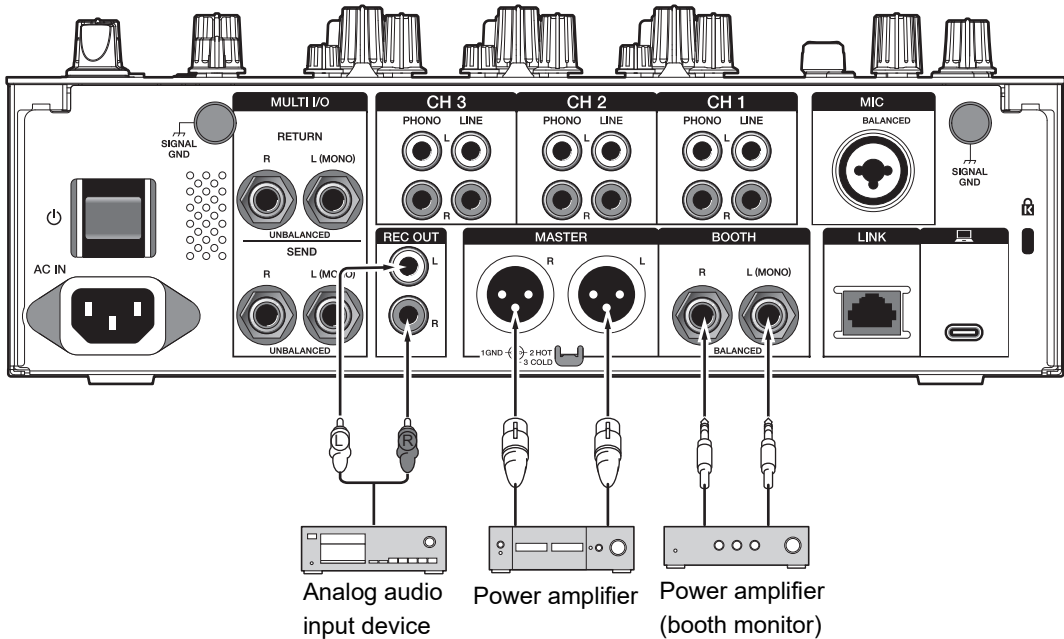

- Use the **[MASTER]** terminals for balanced output only. Connecting the terminals to unbalanced inputs (RCA, etc.) with an XLR-RCA conversion cable (conversion adapter), etc. results in unwanted noises and/or poor sound quality.
- Use the **[BOOTH]** terminals for balanced output only. Connecting the terminals to unbalanced inputs results in unwanted noises and/or poor sound quality.
- Do not connect a power cord from another product or a terminal that can supply phantom power to the **[MASTER]** terminals.

Connecting to the terminals on the top panel

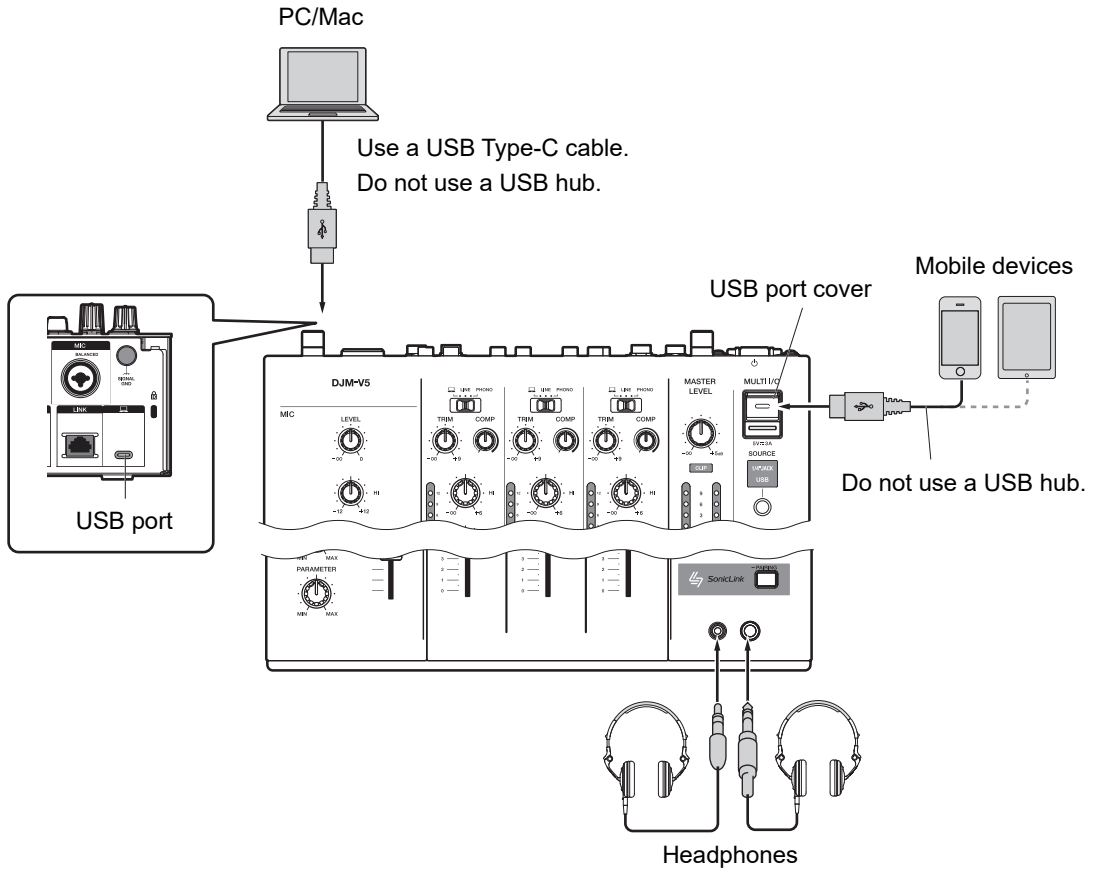

- To input or output your PC/Mac's audio to/from the unit, install the dedicated software on your computer.

⇒ [Installing the dedicated software \(page 14\)](#)

- Do not press or pull the USB port cover with excessive force, or it may be damaged.
- Use a cable supplied with a mobile device for connecting it to the unit.
- For a list of the mobile devices supported by the unit, visit the URL below.

alphatheta.com/support/

- To connect an effects unit, use a USB cable no longer than 3 m.
- Connect headphones to one of the terminals (jack or mini-jack). If you use both terminals at the same time, the volume for headphones may decrease and/or the sound quality may deteriorate.

Connecting to the MULTI I/O terminals

- Connect as follows to use external effects units or mobile devices with MULTI I/O.
 - [MULTI I/O, SEND] terminals (output) → effects unit → [MULTI I/O, RETURN] terminals (input port)
 - USB port (input/output port) on the MULTI I/O section → mobile device
 - USB port (input/output port) on the MULTI I/O section → effects unit that can be connected via a USB cable

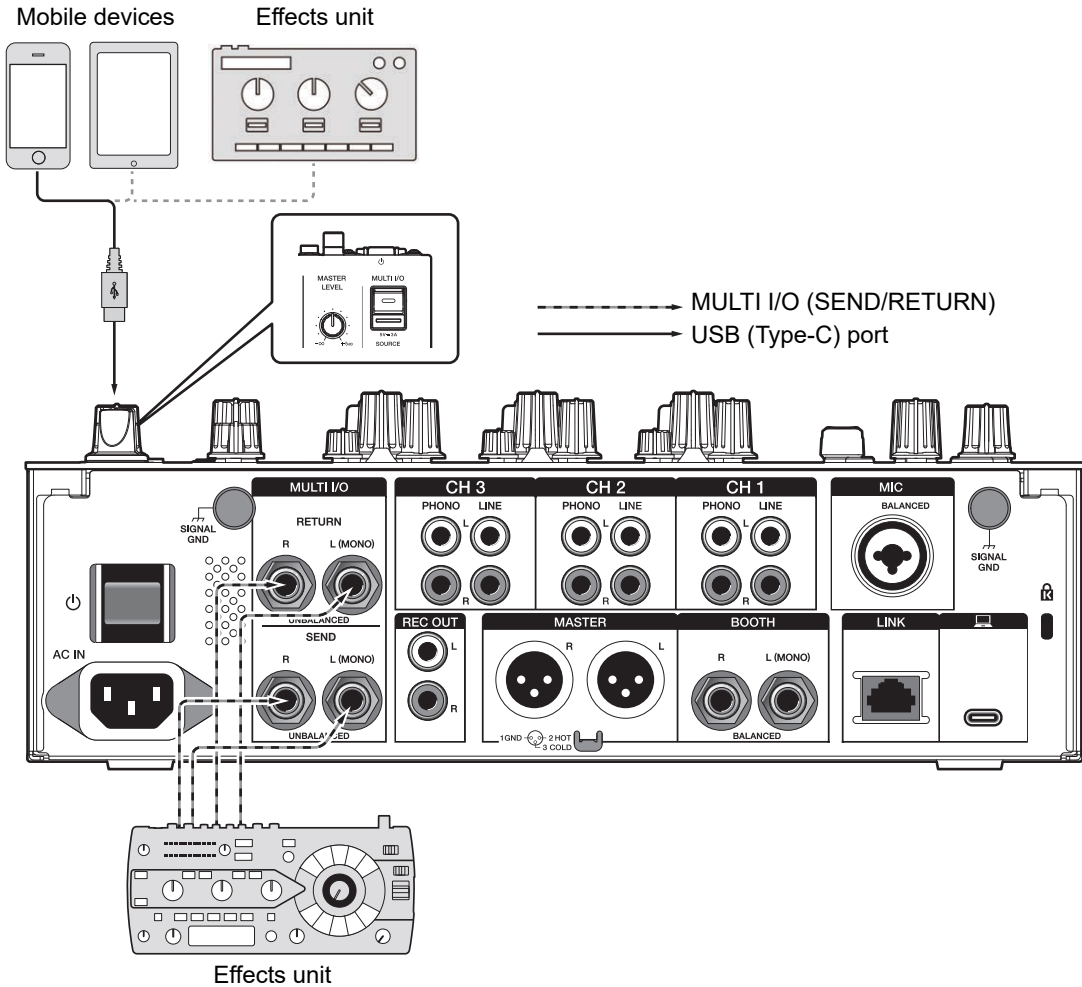

⇒ [MULTI I/O \(page 45\)](#)

Audio output

Follow the procedures below to output and adjust sound.

- Outputting sound (page 28)
- Adjusting the sound (page 29)
- Setting the fader curves (page 29)
- Adjusting the left/right sound balance (page 29)
- To output sound to the **[BOOTH]** terminals, see Using a booth monitor (page 34).

Channel/master section

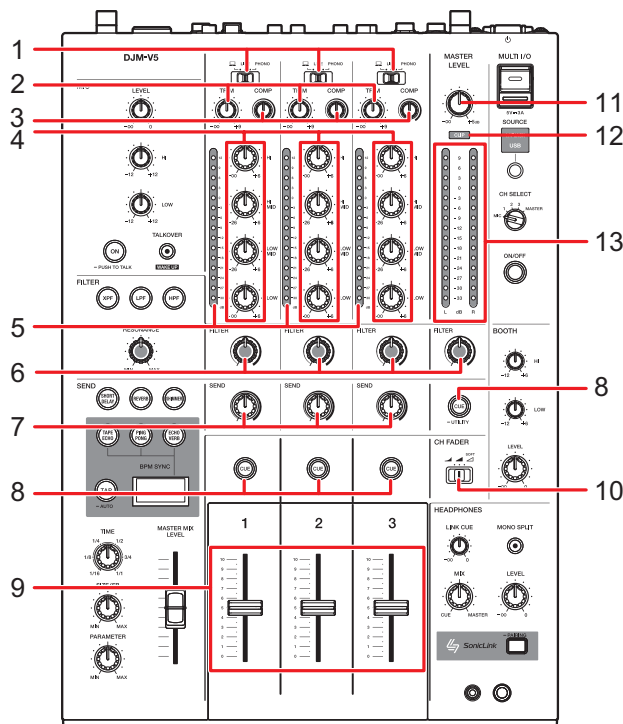

❖ Channel section

1. Input selector switch

Selects an input sound source.

- **[]**: Selects a PC/Mac connected to the **[USB]** port.
- **[LINE]**: Selects a multi player, etc. connected to the **[LINE]** terminals.

— **[PHONO]**: Selects a turntable connected to the **[PHONO]** terminals.

⇒ [Outputting sound \(page 28\)](#)

2. **TRIM knobs**

Adjusts the volume for the channel input sound.

3. **COMP knobs**

Adjusts the sound pressure.

Turning clockwise increases the pressure.

Turning all the way counterclockwise outputs the original sound.

4. **EQ (HI, HI MID, LOW MID, LOW) knobs**

Adjusts the volume of each frequency band.

Each knob adjusts in the following range.

— **[HI]**: -∞ dB to +6 dB

— **[HI MID]**: -26 dB to +6 dB

— **[LOW MID]**: -26 dB to +6 dB

— **[LOW]**: -∞ dB to +6 dB

5. **Channel level indicator**

Displays the volume level before the sound passes through the channel fader.

6. **FILTER knob**

⇒ [Using the Filter \(page 38\)](#)

7. **SEND knob**

⇒ [Routing effect sounds to the master sound \(page 41\)](#)

8. **CUE button**

⇒ [Monitoring with headphones \(page 32\)](#)

9. **Channel fader**

Adjusts the volume for the channel output sound according to the channel fader curve specified with the **[CH FADER]** selector switch. Moving it up increases the volume, and down decreases the volume.

⇒ [Setting the fader curves \(page 29\)](#)

10. **CH FADER selector switch**

⇒ [Setting the fader curves \(page 29\)](#)

❖ **MASTER section**

11. **MASTER LEVEL knob**

Adjusts the volume for the master sound.

12. CLIP indicator

Blinks when excessive volume is output from the [MASTER] terminals.

13. Master level indicator

Displays the volume level of the master sound output to the [MASTER] terminals.

Outputting sound

Adjusting the channel input volume

- 1 Slide the input selector switch to select an input sound source.
- 2 Turn the [TRIM] knob to adjust the volume for the input sound.

The channel level indicator lights up when sound is input to the channel.

Adjusting the channel output volume

- 1 Move the channel fader to adjust the volume for the output sound.

Adjusting the master sound volume

- 1 Turn the [MASTER LEVEL] knob to adjust the volume for the master sound.



The master level indicator lights up when the master sound is output.

Adjusting the sound

- 1 Turn the [EQ (HI, HI MID, LOW MID, LOW)] knobs to adjust the volume of each band.
- 2 Turn the [COMP] knob to adjust the sound pressure.

Setting the fader curves

Set the channel fader curve.

- 1 Set the [CH FADER] selector switch to a channel fader curve.
 - : Steeply raises the volume when the channel fader is moved close to the top position.
 - : Gradually raises the volume as the channel fader is moved up.
 - : Gradually raises the volume and opens the filter as the channel fader is moved up.

Adjusting the left/right sound balance

You can adjust the left/right balance for the sounds output from the following terminals.

- [MASTER]
 - [BOOTH]
 - [REC OUT]
 - USB port
 - [PHONES]
- You can adjust the left/right balance for the sound output from the USB port only when [MIX (REC OUT with MIC)] or [MIX (REC OUT without MIC)] is selected for [Mixer Audio Output] in Settings Utility.
- ⇒ [Mixer Audio Output pull-down menu \(page 20\)](#)

1 Press and hold the [MASTER CUE (UTILITY)] button for more than a second.

The [UTILITY] screen appears.

2 Select [BALANCE], and press the [CUE] button for CH 2.

The [BALANCE] screen appears.

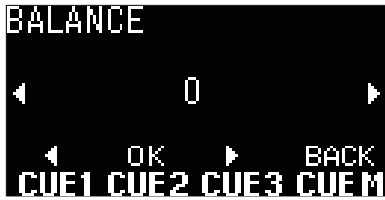

3 Press the [CUE] button for CH 1/CH 3 to adjust the left/right balance.

- Only the left channel sound of stereo audio is output when set to the [L] (leftmost) position, and only the right channel sound is output when set to the [R] (rightmost) position.

4 Press the [CUE] button for CH 2.

- To cancel the setting, press the [CUE] button for MASTER.

5 Press the [CUE] button for MASTER.

The [UTILITY] screen closes.

Monitoring sound

Headphones sections

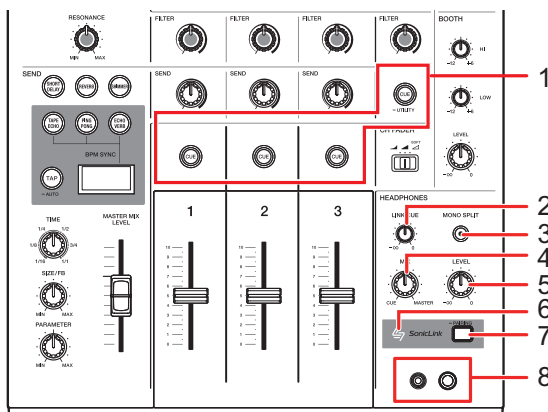

1. **CUE button**

Outputs the sound to the **[PHONES]** terminals and SonicLink headphones.

2. **LINK CUE knob**

Adjusts the LINK MONITOR volume.

3. **MONO SPLIT button**

Sets the sound output method (MONO SPLIT/stereo) for the headphones.

Outputs the sound of the channel with the **[CUE]** button pressed to the left channel of your headphones, and the master sound to the right channel when the button is lit.

Outputs the stereo sound of the channel with the **[CUE]** button pressed when the button is turned off.

4. **MIX knob**

Adjusts the volume balance between the channel with the **[CUE]** button pressed and the master sound.

5. **LEVEL knob**

Adjusts the volume for the headphones monitor sound.

6. **SonicLink headphones indicator**

⇒ [Monitoring with SonicLink headphones \(page 33\)](#)

7. **PAIRING** button

Pairs the unit with SonicLink headphones.

⇒ [Monitoring with SonicLink headphones \(page 33\)](#)

8. **PHONES** terminals

Connect headphones.

Monitoring with headphones

1 **Connect headphones to the [PHONES] terminal.**

⇒ [Connecting to the terminals on the top panel \(page 24\)](#)

2 **Press the [CUE] button or turn the [LINK CUE] knob to select the sound you want to monitor.**

3 **Press the [MONO SPLIT] button to set the sound output method (MONO SPLIT/stereo).**

4 **Turn the [MIX] knob to adjust the volume balance between the channel with the [CUE] button pressed and the master sound.**

5 **Turn the [LEVEL] knob to adjust the volume for the channel with the [CUE] button pressed.**

- Press the [CUE] button again to turn off monitoring.

Monitoring with SonicLink headphones

1 Set [SONICLINK] to [ON] in the Utility settings.

⇒ [Utility settings \(page 50\)](#)

2 Turn on SonicLink headphones and put them into Pairing mode.

- You don't need to turn SonicLink headphones on when you pair them with the unit using near-field communication.
- For details on the pairing procedure for SonicLink headphones, refer to their instruction manual.

3 Press and hold the [PAIRING] button, or hold the SonicLink headphones over the headphones touch area on the front panel of the unit for a while (to use near-field communication).

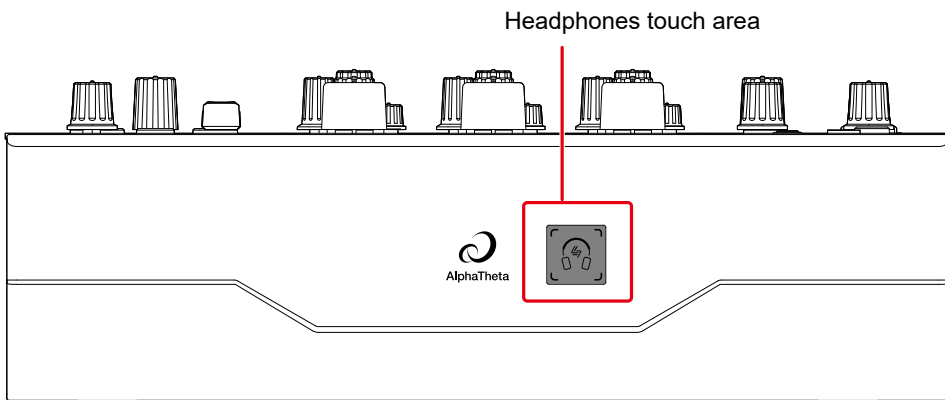

- If you press and hold the [PAIRING] button, the unit enters Pairing mode.
- The SonicLink headphones indicator blinks quickly during pairing, and the light turns solid when the headphones are paired with the unit.
- If you use the headphones that were last paired with the unit, they'll automatically connect when you turn them on – there's no need to use the [PAIRING] button.
- For information on the touch area on your SonicLink headphones, refer to their instruction manual.

Booth section

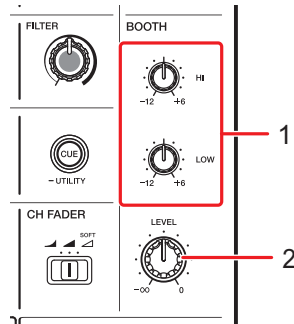

1. EQ (HI, LOW) knobs

Adjusts the volume of each band.

Each knob adjusts in the following range.

- **[HI]**: -12 dB to +6 dB
- **[LOW]**: -12 dB to +6 dB

2. LEVEL knob

Adjusts the volume for the sound output to a booth monitor.

Using a booth monitor

1 Connect a booth monitor to the [BOOTH] terminals.

⇒ [Connecting to the output terminals \(page 23\)](#)

2 Turn the [LEVEL] knob to adjust the volume for the output sound.

3 Turn the [EQ (HI, LOW)] knobs to adjust the volume of each band.

Microphone

MIC section

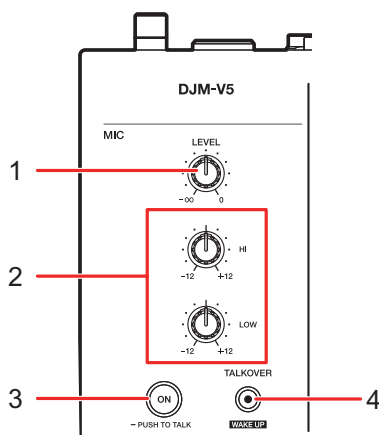

1. LEVEL knob

Adjusts the volume of sound input from the **[MIC]** terminal.

2. EQ (HI, LOW) knobs

Adjusts the volume of sound input from the **[MIC]** terminal.

Each knob adjusts in the following range.

- **[HI]**: -12 dB to +12 dB
- **[LOW]**: -12 dB to +12 dB

3. ON button

Sets the microphone sound output. The button lights up when the microphone is turned on.

Press and hold to turn Push To Talk on. The microphone is turned on while pressing the button.

4. TALKOVER (WAKE UP) button

Turns microphone talkover on and off. The button lights up when it's turned on.

If sound is input to the microphone when it's turned on, the volume other than the microphone channel is attenuated.

- You can change the talkover mode setting in **[TALKOVER MODE]** in the My Settings.
⇒ [TALKOVER MODE \(page 53\)](#)

- You can change the attenuation level in [TALKOVER LEVEL] in the My Settings.
⇒ [TALKOVER LEVEL \(page 53\)](#)

Using a microphone

1 Connect a microphone to the [MIC] terminal.

⇒ [Connecting to the input terminals \(page 22\)](#)

2 Press the [TALKOVER (WAKE UP)] button to turn the microphone talkover on or off.

3 Press the [ON] button to turn the microphone on.

4 Turn the [LEVEL] knob to adjust the microphone volume level.

- Note that turning the knob too far clockwise outputs the sound at a high volume.

5 Turn the [EQ (HI, LOW)] knobs to adjust the volume of each band.

6 Speak into the microphone.

Filter

You can adjust the cut-off frequency.

The selected filter is applied to the master channel and all of channels 1 to 3.

Filter section

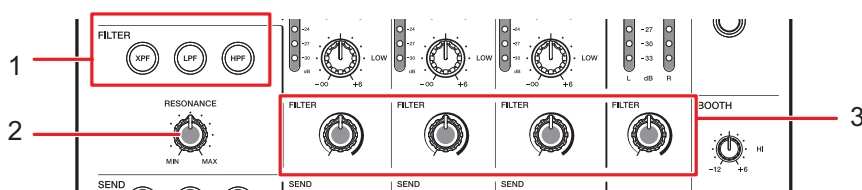

1. FILTER (XPF, LPF, HPF) buttons

Select a filter. The selected button blinks.

- **[XPF]**: CROSS PASS FILTER (HIGH PASS FILTER that doesn't cut the low frequency)
- **[LPF]**: LOW PASS FILTER
- **[HPF]**: HIGH PASS FILTER

2. RESONANCE knob

Adjusts the resonance. Turning the knob clockwise increases the resonance.

3. FILTER knob

Adjusts the cut-off frequency.

Depending on the selected **[FILTER (XPF, LPF, HPF)]** button, the filter changes as follows:

- **[XPF]**: Turning the knob clockwise raises the cut-off frequency.
- **[LPF]**: Turning the knob clockwise lowers the cut-off frequency
- **[HPF]**: Turning the knob clockwise raises the cut-off frequency.

Using the Filter

1 Press a [FILTER (XPF, LPF, HPF)] button to select a filter.

- If either button is already selected, pressing the other button switches to that filter.

2 Turn the [FILTER] knob to adjust the cut-off frequency.

3 Turn the [RESONANCE] knob to adjust the resonance.

- Press the blinking [FILTER (XPF, LPF, HPF)] button to turn the filter off.

Send

You can route the effect sound (reverberation) of one of the built-in FX to the master sound.

Send section

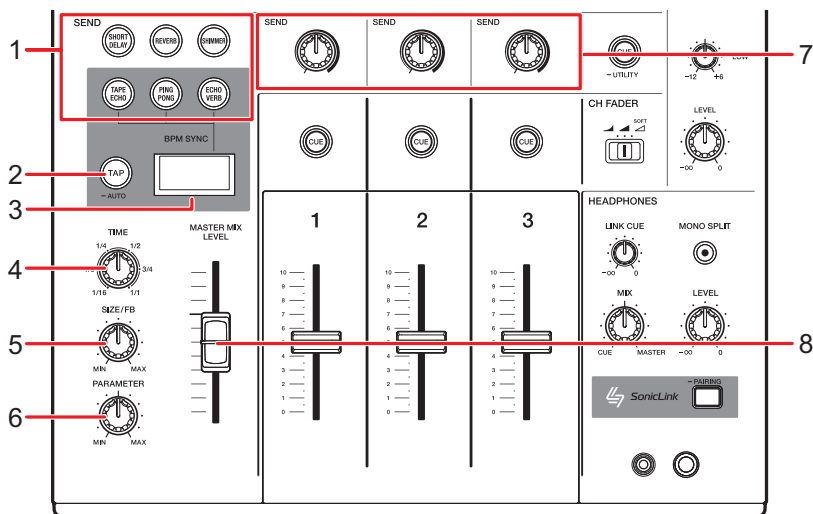

1. SEND buttons

2. TAP button

Sets BPM measuring method (AUTO/TAP). The selected measuring method is displayed on the screen.

- AUTO mode: Automatically measures BPM of the master sound (measuring range: 70 to 180).
- TAP (manual input) mode: Manually sets a BPM by tapping the button multiple times.

- It's automatically set to AUTO mode when the unit is turned on.

3. Screen

4. TIME knob

5. SIZE/FB knob

6. PARAMETER knob

7. SEND knob

Adjusts the Send FX level.

8. MASTER MIX LEVEL fader

Adjusts the volume for the Send FX sound that is routed to the master sound.

Screen

- The screen automatically dims if no audio is input to or output from the unit, or if the unit is left unused, for 5 minutes. The brightness is restored when audio is input to or output from the unit, or the unit is used.

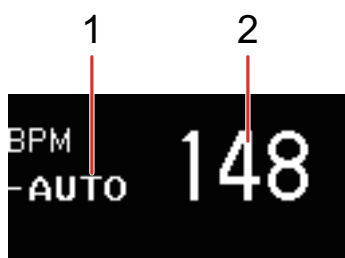

1. AUTO/TAP

Displays [AUTO] when in automatic BPM measuring mode, and [TAP] when in manual BPM input mode.

- The BPM value blinks when it can't be measured correctly in the [AUTO] setting. Use the [TAP] mode if this happens.

2. BPM value

Routing effect sounds to the master sound

You can route the effect sound of one of the built-in FX to the master sound.

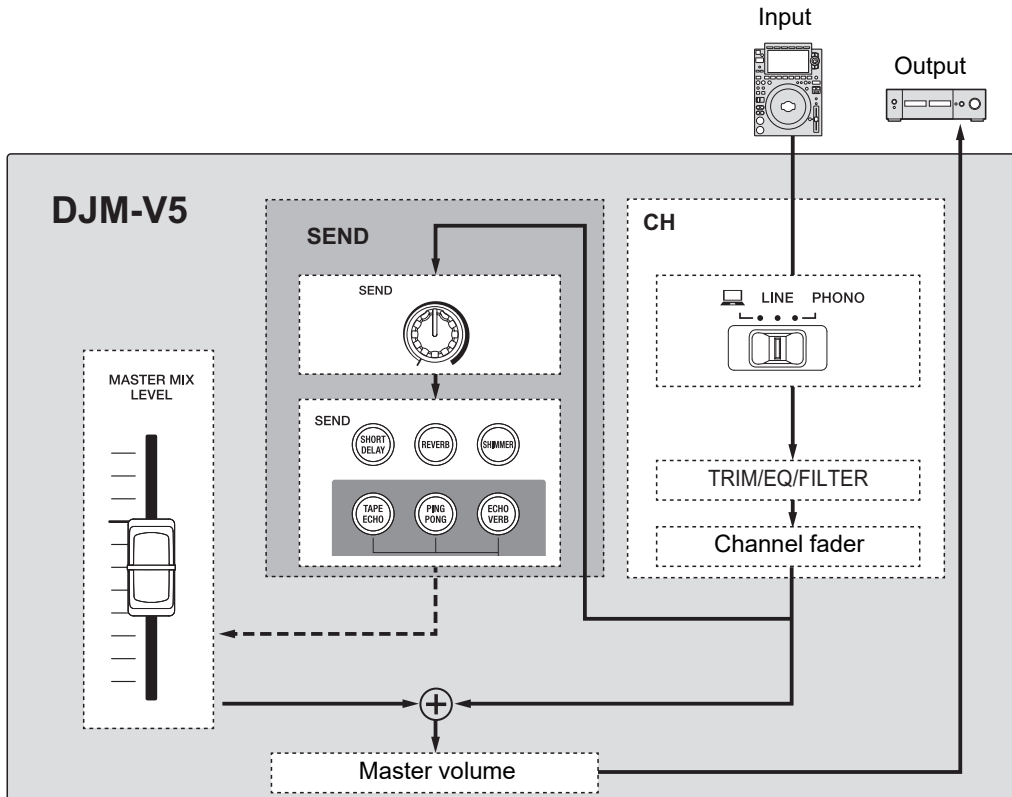

⇒ [Send FX and settings \(page 43\)](#)

- 1 Press one of the [SEND] buttons to select an effect.
- 2 Turn the [SIZE/FB] knob to adjust the quantitative parameter for the effect.
- 3 Turn the [TIME] knob to adjust the time parameter for the effect.
- 4 Turn the [PARAMETER] knob to adjust the sound to apply to the effect sound.

5 Slide the [MASTER MIX LEVEL] fader to adjust the effect volume.

6 Turn the [SEND] knob to adjust the Send FX level.

- Press the blinking [SEND] button to turn Send off.

Setting the BPM manually

1 Tap the [TAP] button more than twice in time with the beat of the track.

The BPM is set according to the average time between taps.

- The BPM range that can be set is 40 to 999.

Send FX and settings

You can adjust the following Send (built-in FX) settings with the relevant knobs.

- The selected [**SEND**] button blinks.

Send FX/knobs	Descriptions
SHORT DELAY	Adds short delay sounds.
• TIME:	Turning clockwise increases delay time.
• SIZE/FB:	Turning clockwise increases the feedback.
• PARAMETER:	Sets cut-off frequency for filter.
REVERB	Adds reverberation.
• TIME:	Turning clockwise increases reverberation time.
• SIZE/FB:	Turning clockwise increases the room size.
• PARAMETER:	Sets cut-off frequency for filter.
SHIMMER	Adds a sparkling reverberation.
• TIME:	Turning clockwise increases reverberation time.
• SIZE/FB:	Turning clockwise increases sparkling reverberation.
• PARAMETER:	Sets cut-off frequency for filter.
TAPE ECHO	Adds a delay sound with a fluctuating or saturated feel.
• TIME*:	Sets delay time between 1/16 to 1 beats with respect to the set BPM.
• SIZE/FB:	Turning clockwise increases the feedback.
• PARAMETER:	Sets cut-off frequency for filter.

Send FX/knobs	Descriptions
PING PONG	Adds delay sound which is alternately output from L/R.
• TIME*:	Sets delay time between 1/16 to 1 beats with respect to the set BPM.
• SIZE/FB:	Turning clockwise increases the feedback.
• PARAMETER:	Sets delay time balance between the left and right.
ECHO VERB	Adds clear delay sound and reverberation.
• TIME*:	Sets delay time and reverberation between 1/16 to 1 beats with respect to the set BPM.
• SIZE/FB:	Turning clockwise increases delay sound feedback.
• PARAMETER:	Sets balance between delay sound and reverberation.

* If you set the knob to the beat fraction printed around the knob, you'll feel a click.

MULTI I/O

You can route the effect sound of an external effects unit or a mobile device (running an FX application) to the channels or the master sound.

You can route effects in the following ways.

- **INSERT method:** Replaces the original sound with the effect sound from an external device.

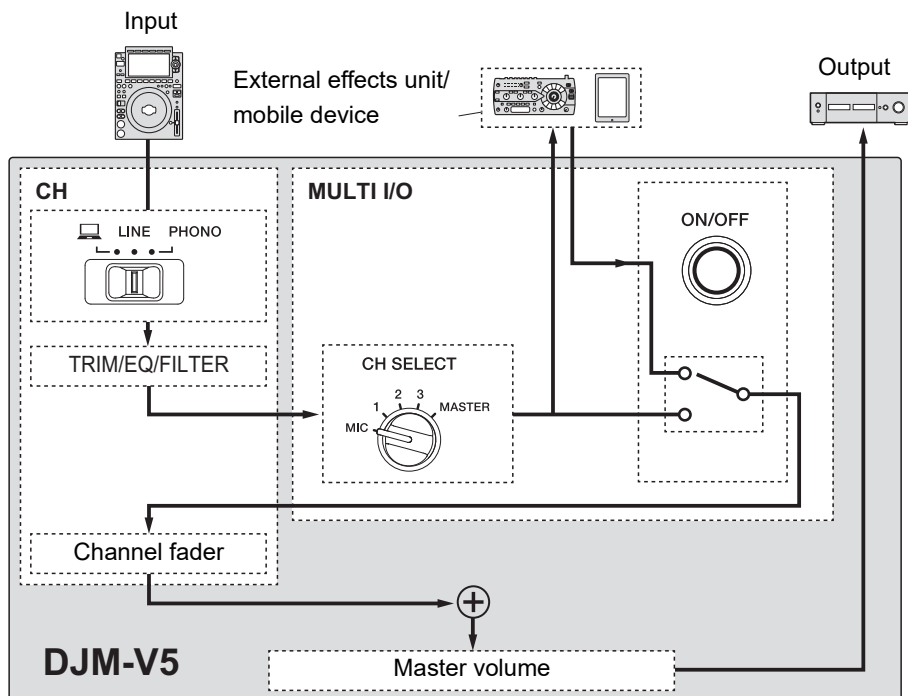

⇒ [Connecting to the MULTI I/O terminals \(page 25\).](#)

MULTI I/O section

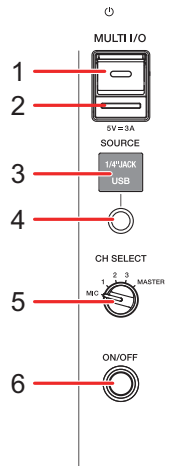

1. USB port

Connect a mobile device or compatible device.

- Connect a mobile device that has a USB Type-C port. The unit doesn't support mobile devices that use Lightning connections.

2. USB connection indicator

Lights up when a compatible device is connected, and blinks when an incompatible device is connected.

3. SOURCE indicator

Indicates an external effects unit selected with the [**SOURCE**] selector button.

4. SOURCE selector button

Selects an external effects unit.

- [**USB**]: Selects a mobile device connected to the USB port.
- [**1/4"JACK**]: Selects an external effects unit connected to the [**MULTI I/O, RETURN**] terminals.

5. CH SELECT switch

Selects a channel to add the MULTI I/O effect to.

6. ON/OFF button

Turns on and off MULTI I/O. The button blinks when it is turned on.

Using MULTI I/O

- 1 Press the [SOURCE] selector button to select an external effects unit.**
- 2 Turn the [CH SELECT] switch to select a channel to add the MULTI I/O effect to.**
- 3 Press the [ON/OFF] button to turn on MULTI I/O.**
 - Press the [ON/OFF] button again to turn off MULTI I/O.
 - MULTI I/O turns off automatically when the unit isn't connected with an external effects unit.

USB/MIDI

If you connect a PC/Mac or mobile device with MIDI software installed, to the unit via a USB cable, you can control the MIDI software via the unit.

- For details on the unit's MIDI messages, visit the URL below.

alphatheta.com/support/

- Set the MIDI channel for outputting MIDI in **[MIDI]** in My Settings.
⇒ [MIDI*1 \(page 54\)](#)
- MIDI timing clock is always sent.

Controlling MIDI software

- Install MIDI software and configure the audio and MIDI settings on a PC/Mac or mobile device beforehand.

1 Connect a PC/Mac or mobile device to the unit.

- Connect a PC/Mac to the [] (USB) port, or connect a mobile device to the mobile device connection terminal (USB port) on the **[MULTI I/O]** section.
⇒ [Connecting to the input terminals \(page 22\)](#)
⇒ [MULTI I/O section \(page 46\)](#)

2 Launch the MIDI software.

The unit starts communication with the MIDI software.

Settings

You can change the unit's settings in the Utility settings. If you save My Settings to a storage device, you can load them to the unit immediately when you arrive in the booth or take over from another DJ, etc.

Changing the settings

1 Press and hold the [CUE (UTILITY)] button for MASTER while the main screen is showing.

The [UTILITY] screen appears.

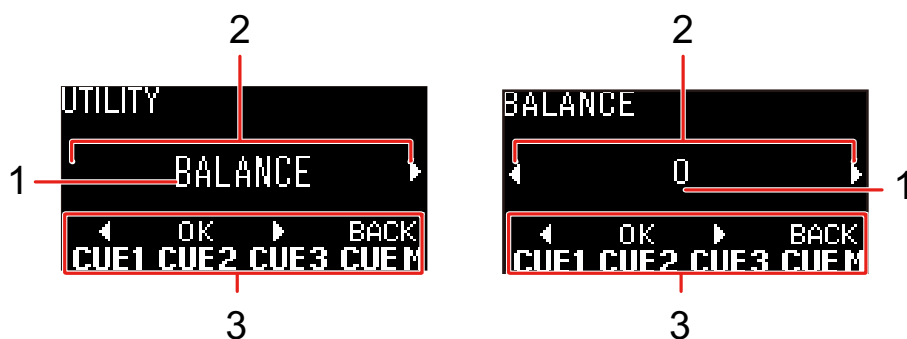

1. Setting items/current setting value
2. ◀ (press the [CUE] button for CH 1 to display the previous page)/▶ (press the [CUE] button for CH 3 to display the next page)
3. Button function descriptions

2 Press the [CUE] button for CH 1/CH 3 to display the desired setting item, then press the [CUE] button for CH 2.

The setting item is selected.

⇒ [Utility settings \(page 50\)](#)

3 Press the [CUE] button for CH 1/CH 3 to change the setting, then press the [CUE] button for CH 2.

The setting changes and the screen returns to the previous (setting item) display.

- Press the **[CUE (UTILITY)]** button for MASTER to cancel the setting and return to the setting item display.

4 Press the **[CUE (UTILITY)]** button for MASTER.

The **[UTILITY]** screen closes and returns to the main screen.

Utility settings

Setting items	Descriptions
BALANCE ^{*1}	<p>Sets the output balance.</p> <ul style="list-style-type: none"> • Setting values: L128 to 0^{*2} to R127
MASTER OUT ^{*1}	
ATT.	<p>Sets the attenuation level for the sound output from the [MASTER] terminals.</p> <ul style="list-style-type: none"> • Setting values: -12dB, -9dB, -6dB, -3dB, 0dB^{*2}
MONO/STEREO	<p>Sets the output method (mono/stereo) for the sound output from the [MASTER] terminals.</p> <ul style="list-style-type: none"> • Setting values: MONO, STEREO^{*2}
BOOTH OUT ^{*1}	
ATT.	<p>Reduces attenuation level to the sound output from the [BOOTH] terminals.</p> <ul style="list-style-type: none"> • Setting values: -12dB, -9dB, -6dB, -3dB, 0dB^{*2}
MUTE WHEN MIC ON	<p>Sets whether to mute the sound output from the [BOOTH] terminals when the microphone is turned on.</p> <ul style="list-style-type: none"> • Setting values: OFF^{*2}, ON

Setting items	Descriptions
MONO/STEREO	<p>Sets the output method (mono/stereo) for the sound output from the [BOOTH] terminals.</p> <ul style="list-style-type: none"> Setting values: MONO, STEREO^{*2}
<hr/>	
REC OUT ^{*1}	
SOURCE	<p>Sets the type of the sound output from the [REC OUT] terminals.</p> <ul style="list-style-type: none"> Setting values: REC w/ MIC^{*2}, REC w/o MIC, MASTER [REC w/ MIC] outputs the master sound and microphone sound before volume adjustment with the [MASTER LEVEL] knob. [REC w/o MIC] outputs the master sound before volume adjustment with the [MASTER LEVEL] knob. [MASTER] outputs the same sound as the [MASTER] terminals.
<hr/>	
MIC TO BOOTH ^{*1}	
LEVEL	<p>Sets the volume for the microphone sound that's input to the sound output from the [BOOTH] terminals.</p> <ul style="list-style-type: none"> Setting values: OFF, -18dB, -15dB, -12dB, -9dB, -6dB, -3dB, 0dB^{*2}
<hr/>	
POWER MANAGEMENT ^{*1}	<p>Sets the Power Management function. ⇒ Power Management (page 52)</p> <ul style="list-style-type: none"> Setting values: OFF, ON^{*2}
<hr/>	
SONICLINK ^{*1}	<p>Sets the SonicLink function. ⇒ Monitoring with SonicLink headphones (page 33)</p> <ul style="list-style-type: none"> Setting values: OFF, ON^{*2}

Setting items	Descriptions
OWNER SETTING	
SAVE	<p>Saves the Utility settings and My Settings as [OWNER SETTING] on the unit.</p> <ul style="list-style-type: none"> • My Settings saved as [OWNER SETTING] are the default settings when you turn the unit on.
LOAD	<p>Calls up the [OWNER SETTING] (Utility settings and My Settings) saved on the unit.</p>
FIRMWARE VER.	<p>Displays the firmware version of the unit.</p>

*1 The setting is saved on the unit when you execute [**SAVE**] in [**OWNER SETTING**].

*2 Factory setting

Power Management

When [**POWER MANAGEMENT**] is set to [**ON**], the unit automatically enters Off mode after 20 minutes without being used in the following ways.

- No audio signals are input to the channels on the unit.
- There is no PRO DJ LINK connection.

The [**TALKOVER (WAKE UP)**] button lights up in Off mode.

Press the [**TALKOVER (WAKE UP)**] button to cancel Off mode.

- The factory setting is [**ON**].
- Set [**POWER MANAGEMENT**] to [**OFF**] if you don't need to use the Power Management function.
- Power consumption will increase if [**POWER MANAGEMENT**] is set to [**OFF**].

My Settings

Setting items	Descriptions
LOAD	<p>Calls up the My Settings saved on a storage device.</p> <p>⇒ Calling up My Settings saved on a storage device (page 56)</p>
SAVE	<p>Saves the current My Settings to a storage device.</p> <p>⇒ Saving My Settings to a storage device (page 55)</p>
HEADPHONES^{*1}	
MONO SPLIT	<p>Sets the output method (MONO SPLIT or stereo) for the headphones monitor sound.</p> <ul style="list-style-type: none"> Setting values: STEREO^{*2}, MONO SPLIT
MIC^{*1}	
MIC LOW CUT	<p>Sets the low-frequency cut function for the microphone sound.</p> <ul style="list-style-type: none"> Setting values: OFF, ON (for MC)^{*2}
TALKOVER MODE	<p>Sets talkover mode.</p> <ul style="list-style-type: none"> Setting values: ADVANCED^{*2}, NORMAL The [ADVANCED] setting outputs sound by attenuating only the mid-frequency range of the sound from channels other than the [MIC] channels according to the setting of the [LEVEL] knob. The [NORMAL] setting outputs sound by attenuating the sound from channels other than the [MIC] channels according to the [LEVEL] knob setting.
TALKOVER LEVEL	<p>Sets the sound attenuation level for talkover.</p> <ul style="list-style-type: none"> Setting values: $-\infty$, -24dB, -18dB^{*2}, -12dB, -6dB

Setting items	Descriptions
MIDI ^{*1}	
CH	Sets the MIDI channel. <ul style="list-style-type: none"> Setting values: 1^{*2} to 16
BUTTON TYPE	Sets the MIDI signal transmission method. <ul style="list-style-type: none"> Setting values: TOGGLE^{*2}, TRIGGER
BRIGHTNESS ^{*1}	
DISPLAY	Sets the brightness of the display. <ul style="list-style-type: none"> Setting values: 1 to 5^{*2}
INDICATOR	Sets the brightness of LED. <ul style="list-style-type: none"> Setting values: 1 to 3^{*2}

*1 The setting is saved on the unit when you perform [**SAVE**] of [**OWNER SETTING**].

*2 Factory setting

Saving My Settings to a storage device

You can save My Settings on a storage device connected the unit.

- You can also save the settings to rekordbox connected via PRO DJ LINK or storage device connected to other multi player via PRO DJ LINK.

1 Connect a storage device to the USB port.

⇒ [MULTI I/O section \(page 46\)](#)

2 Press and hold the [CUE (UTILITY)] button for MASTER while the main screen is showing.

The [UTILITY] screen appears.

3 Press the [CUE] button for CH 1/CH 3, select [SAVE] of [MY SETTINGS], then press the [CUE] button for CH 2.

4 Press the [CUE] button for CH 1/CH 3 to select a storage device to save the settings to, then press the [CUE] button for CH 2.

My Settings are saved to the storage device.

- Press the [CUE (UTILITY)] button for MASTER to cancel saving the settings and return to the setting item display.

5 Press the [CUE (UTILITY)] button for MASTER.

The [UTILITY] screen closes and returns to the main screen.

Calling up My Settings saved on a storage device

You can call up My Settings on a storage device.

- You can call up My Settings from rekordbox connected via PRO DJ LINK or storage device connected to other multi player via PRO DJ LINK.

1 Connect a storage device to the USB port.

⇒ [MULTI I/O section \(page 46\)](#)

2 Press and hold the [CUE (UTILITY)] button for MASTER while the main screen is showing.

The [UTILITY] screen appears.

3 Press the [CUE] button for CH 1/CH 3, select [LOAD] of [MY SETTINGS], then press the [CUE] button for CH 2.

4 Press the [CUE] button for CH 1/CH 3 to select a storage device to load the settings from, then press the [CUE] button for CH 2.

My Settings are called up.

- Press the [CUE (UTILITY)] button for MASTER to cancel loading the settings and return to the setting item display.

5 Press the [CUE (UTILITY)] button for MASTER.

The [UTILITY] screen closes and returns to the main screen.

Restoring the factory settings

- 1 While pressing the [TALKOVER (WAKE UP)] button, press the [⏻] button.

The [FACTORY RESET] screen appears.

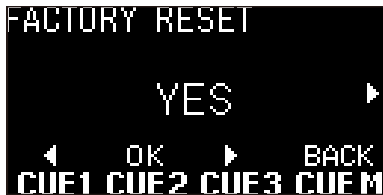

- 2 Press the [CUE] button for CH 1/CH 3 to select [YES], then press the [CUE] button for CH 2.
- 3 Press the [⏻] button to turn the unit off.

The factory settings are restored.

Specifications

General

Power requirements	AC 110 V – 240 V, 50 Hz/60 Hz
--------------------	-------------------------------

Power consumption	47 W
-------------------	------

Power consumption (off)	0.3 W
-------------------------	-------

Main unit weight	8.0 kg/17.6 lbs.
------------------	------------------

Max. external dimensions	(W × D × H) 302.0 × 437.5 × 107.9 mm / 11.89" × 17.22" × 4.25"
--------------------------	--

Tolerable operating temperature	+5 °C – +35 °C (+41 °F – +95 °F)
---------------------------------	----------------------------------

Tolerable operating humidity	5 % – 85 % (no condensation)
------------------------------	------------------------------

Audio section

Sampling rate	96 kHz
---------------	--------

MASTER, BOOTH, REC, SEND D/ A converter	32bit
--	-------

CH, RETURN input A/D converter	32bit
--------------------------------	-------

Other A/D and D/A converters	24bit
------------------------------	-------

Frequency response	
--------------------	--

LINE	20 Hz – 40 kHz
------	----------------

S / N ratio (rated output, A-WEIGHTED)	
--	--

USB	110 dB
-----	--------

PHONO	88 dB
-------	-------

Audio section

LINE	105 dB
------	--------

MIC	79 dB
-----	-------

Total harmonic distortion (LINE — MASTER, 20 Hz – 40 kHzBW)	0.005 %
---	---------

Standard input level / Input impedance

PHONO	-52 dBu/47 kΩ
-------	---------------

LINE	-12 dBu/47 kΩ
------	---------------

MIC	-57 dBu/3.5 kΩ
-----	----------------

RETURN	-12 dBu/47 kΩ
--------	---------------

Max. input level

PHONO	-17.8 dBu
-------	-----------

LINE	+15 dBu
------	---------

MIC	+2 dBu
-----	--------

RETURN	+12 dBu
--------	---------

Standard output level / Load impedance / Output impedance

MASTER	+6 dBu/10 kΩ/360 Ω
--------	--------------------

REC OUT	-8 dBu/10 kΩ/700 Ω
---------	--------------------

BOOTH	+6 dBu/10 kΩ/360 Ω
-------	--------------------

SEND	-12 dBu/10 kΩ/700 Ω
------	---------------------

PHONES	+8 dBu/32 Ω/1 Ω or lower
--------	--------------------------

Audio section

Rated output level / Load impedance

MASTER	+25 dBu/10 k Ω
BOOTH	+25 dBu/10 k Ω

Crosstalk

LINE	82 dB
------	-------

Channel equalizer characteristic

HI	$-\infty$ dB – +6 dB (3 kHz)
HI MID	-26 dB – +6 dB (1.2 kHz)
LOW MID	-26 dB – +6 dB (400 Hz)
LOW	$-\infty$ dB – +6 dB (200 Hz)

Microphone equalizer characteristic

HI	-12 dB – +12 dB (10 kHz)
LOW	-12 dB – +12 dB (100 Hz)

BOOTH MONITOR equalizer feature

HI	-12 dB – +6 dB (3 kHz)
LOW	-12 dB – +6 dB (300 Hz)

Input / Output terminals

PHONO input terminal

RCA pin jacks	3 sets
---------------	--------

Input / Output terminals

LINE input terminal

RCA pin jacks	3 sets
---------------	--------

MIC input terminal (XLR / TRS)

XLR connector & 1/4" TRS jack	1 set
-------------------------------	-------

RETURN input terminals (TS)

1/4" TS jack	1 set
--------------	-------

MASTER output terminal

XLR connector	1 set
---------------	-------

BOOTH output terminal (TRS)

1/4" TRS jack	1 set
---------------	-------

REC OUT output terminal

RCA pin jacks	1 set
---------------	-------

SEND output terminal (TS)

1/4" TS jack	1 set
--------------	-------

PHONES output terminal

1/4" stereo jack	1 set
------------------	-------

3.5 mm stereo mini-jack	1 set
-------------------------	-------

USB terminal

USB Type-C (MULTI I/O)	1 set
------------------------	-------

Power supply	5 V/3 A or less
--------------	-----------------

Input / Output terminals

USB Type-C (PC/Mac)	1 set
---------------------	-------

LINK terminal

LAN terminal (100BASE-TX)	1 set
---------------------------	-------

SonicLink section

Maximum transmission distance	Approximately 5 m* in unobstructed circumstances
-------------------------------	--

Frequency band used	2.4 GHz
---------------------	---------

-
- * Transmission distances are a guideline. Transmission distance may change depending on the surrounding environment.

Headphones touch area

Supported standards	ISO/IEC 15693 (reader)
---------------------	------------------------

The specifications and design of this product are subject to change without notice.

Block diagram

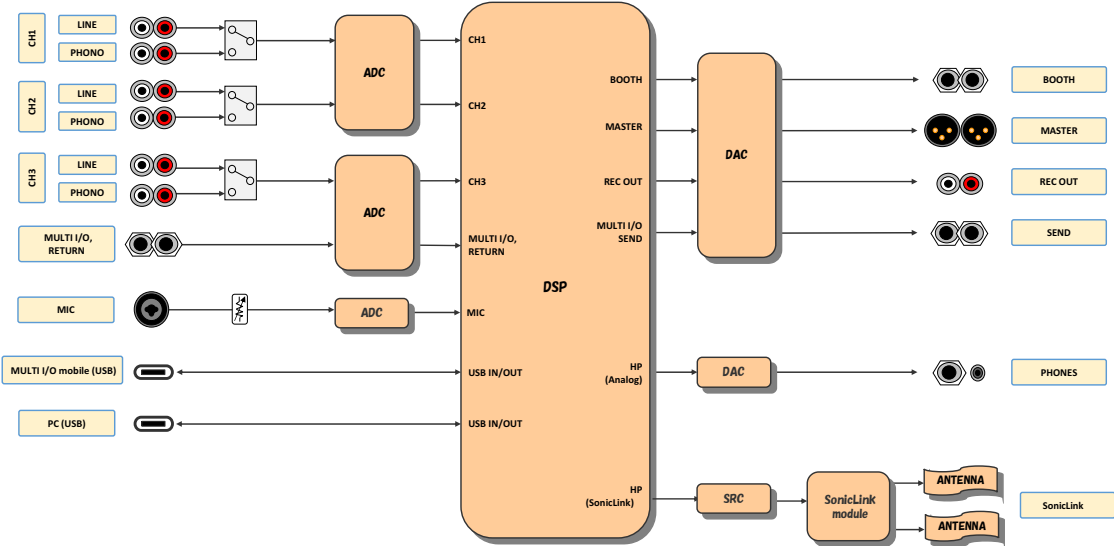

Specifications

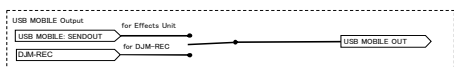
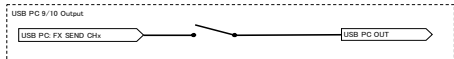
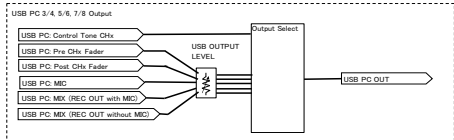
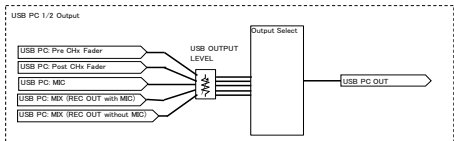
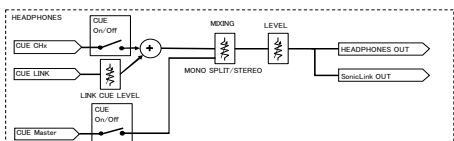
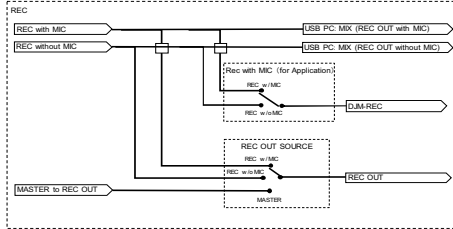
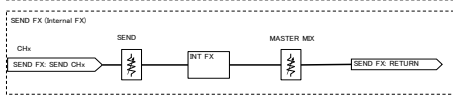
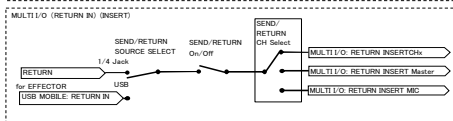
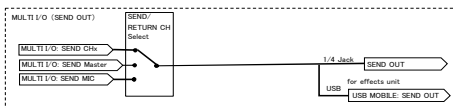
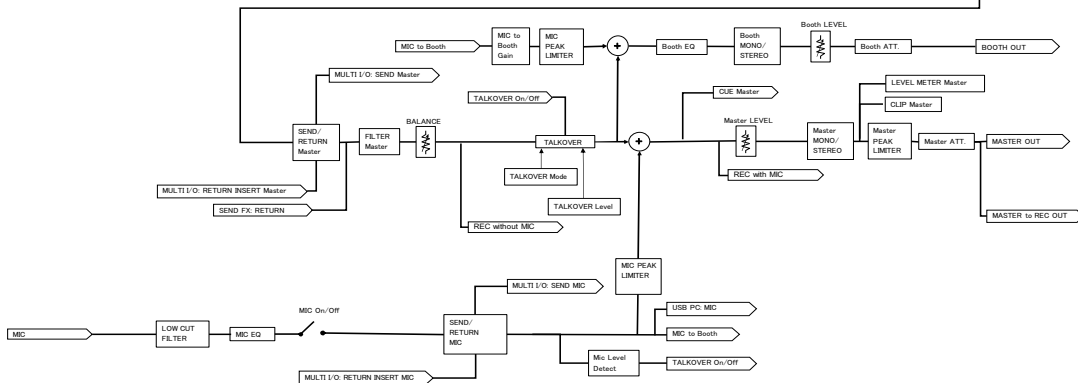
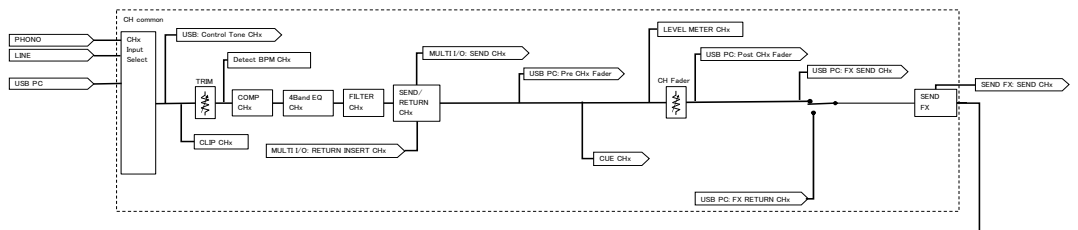

Additional information

Troubleshooting

If you think something is wrong with the unit, check the information below and refer to the [FAQ] for the DJM-V5 at the URL below.

alphatheta.com/support/

- Inspect devices connected with the unit.
- The unit may restore proper operation after you turn it off and on.

If the problems continue, read the Precautions for Use and consult an authorized service company or your dealer.

Power

❖ You can't turn the unit on.

- Check if the power cord is properly connected to the unit and an AC outlet.

Audio output

❖ Sound isn't outputting or the volume is low.

- Check the input selector switches are set properly.
- Check all cables are connected properly.
- Wipe any dust or dirt off the terminals and plugs before connecting them.
- Change [ATT.] in [MASTER OUT] in the Utility settings.

❖ Sound is distorted.

For the master sound:

- Adjust the [LEVEL] knob on the MASTER section so the master level indicator lights up with the peak level at around 0 dB.
- Set [ATT.] to a setting between [-3 dB] and [-12 dB] in [MASTER OUT] in the Utility settings.

For the channel input sound:

- Adjust the [TRIM] knob so the channel level indicator lights up with the peak level at around 0 dB.

Effects

❖ Send doesn't work.

- Make sure the [SEND] knob is set properly.

❖ The Send FX sound isn't input to the master sound.

- Make sure the [MASTER MIX LEVEL] fader in the [SEND] section is set properly.

❖ You can't feel a click when operating the [TIME] knob.

- You'll feel a click when [TAPE ECHO], [ECHO VERB], or [PINGPONG] is selected with the [SEND] button.

❖ An external effects unit or a mobile device connected to the [MULTI I/O, SEND] terminals doesn't work.

- Connect a mobile device that has a USB Type-C port. The unit doesn't support mobile devices that use Lightning connections.
- Select a channel to add the effect to with the [CH SELECT] switch.
- Press the [ON/OFF] button in the [MULTI I/O] section to turn on MULTI I/O.
- Carefully connect an external effects unit to the [MULTI I/O, SEND] and [MULTI I/O, RETURN] terminals.
- Make sure mobile devices are properly connected to the USB port in the [MULTI I/O] section. Launch the FX application on the mobile device.
- Make sure the [SOURCE] selector button is set properly.

❖ Sound from an external effects unit is distorted.

- Make sure the volume for the external effects unit is set properly.

❖ The tempo (BPM) of a track can't be measured. The measured BPM is wrong.

- Adjust the [TRIM] knob so the channel level indicator lights up with the peak level at around 0 dB.

- Tempo (BPM) can't be measured for some tracks. Use the [TAP] button to manually set the tempo for those tracks.

❖ **The measured tempo (BPM) differs from the value on the CD.**

- The values don't match when BPM measuring methods are different.

MIDI

❖ **You can't control a MIDI device with the unit.**

- Assign this unit's MIDI messages to the software. For details on assignment, refer to the instruction manual for the software.

Connections

❖ **The unit isn't recognized by the connected PC/Mac.**

- Install the dedicated software on the PC/Mac. If the software is already installed, reinstall it.

❖ **The unit isn't recognized by the connected mobile device.**

- Connect a mobile device that has a USB Type-C port. The unit doesn't support mobile devices that use Lightning connections.

❖ **Sound from the connected PC/Mac isn't outputting from the unit.**

- Make sure the PC/Mac is connected properly (do not use a USB hub – connect directly to the unit).
- Select this unit in the audio output device settings in the software. For details, refer to the instruction manual for the software.
- Set the input selector switches to [PC].

❖ **Sound is distorted when a turntable is connected to the [PHONO] terminals on the unit. The status of the channel level indicator doesn't change when you turn the [TRIM] knob.**

- Check if the connected turntable has a built-in phono equalizer (if it does, connect the turntable to the [LINE] terminals).
- If the turntable has a PHONO/LINE selector switch, set it to PHONO.

- If the audio interface for PC/Mac, which is connected between the unit and the turntable, is a line-level device, connect the turntable to the [**LINE**] terminals.

Cleaning

- Wipe with a dry soft cloth.
- Do not use organic solvents, acids or alkalis for cleaning.

Trademarks and registered trademarks

- rekordbox™ is a trademark or registered trademark of AlphaTheta Corporation.
- PRO DJ LINK™ is a trademark or registered trademark of AlphaTheta Corporation.
- iPad, iPadOS, Mac, macOS and Finder are trademarks of Apple Inc., registered in the U.S. and other countries and regions.
- Windows is a trademark or registered trademark of Microsoft Corporation in the U.S. and other countries.
- ASIO is a trademark or registered trademark of Steinberg Media Technologies GmbH.
- SonicLink™ is a trademark or registered trademark of AlphaTheta Corporation.
- Android is a trademark of Google LLC.
- iOS is a trademark or registered trademark of Cisco in the U.S. and other countries and regions.

Other product, technology and company names, etc. mentioned herein are trademarks or registered trademarks of their respective owners.

About using MP3 files

This product has been licensed for nonprofit use. This product has not been licensed for commercial purposes (for profit-making use), such as broadcasting (terrestrial, satellite, cable or other types of broadcasting), streaming on the Internet, Intranet (a corporate network) or other types of networks or distributing of electronic information (online digital music distribution service). You need to acquire the corresponding licenses for such uses. For details, see <http://www.mp3licensing.com>.

Software license notice

The licenses for the open source software used on this player are shown below. For accuracy purposes, here we have included the original texts (in English).

Copyright © 2010 Texas Instruments Incorporated - <http://www.ti.com/>

Redistribution and use in source and binary forms, with or without modification, are permitted provided that the following conditions are met:

Redistributions of source code must retain the above copyright notice, this list of conditions and the following disclaimer.

Redistributions in binary form must reproduce the above copyright notice, this list of conditions and the following disclaimer in the documentation and/or other materials provided with the distribution.

Neither the name of Texas Instruments Incorporated nor the names of its contributors may be used to endorse or promote products derived from this software without specific prior written permission.

THIS SOFTWARE IS PROVIDED BY THE COPYRIGHT HOLDERS AND CONTRIBUTORS «AS IS» AND ANY EXPRESS OR IMPLIED WARRANTIES, INCLUDING, BUT NOT LIMITED TO, THE IMPLIED WARRANTIES OF MERCHANTABILITY AND FITNESS FOR A PARTICULAR PURPOSE ARE DISCLAIMED. IN NO EVENT SHALL THE COPYRIGHT OWNER OR CONTRIBUTORS BE LIABLE FOR ANY DIRECT, INDIRECT, INCIDENTAL, SPECIAL, EXEMPLARY, OR CONSEQUENTIAL DAMAGES (INCLUDING, BUT NOT LIMITED TO, PROCUREMENT OF SUBSTITUTE GOODS OR SERVICES; LOSS OF USE, DATA, OR PROFITS; OR BUSINESS INTERRUPTION) HOWEVER CAUSED AND ON ANY THEORY OF LIABILITY, WHETHER IN CONTRACT, STRICT LIABILITY, OR TORT (INCLUDING NEGLIGENCE OR OTHERWISE) ARISING IN ANY WAY OUT OF THE USE OF THIS SOFTWARE, EVEN IF ADVISED OF THE POSSIBILITY OF SUCH DAMAGE.

Apache

Copyright (c) 2009-2019 ARM Limited. All rights reserved.

SPDX-License-Identifier: Apache-2.0

Licensed under the Apache License, Version 2.0 (the License); you may not use this file except in compliance with the License.

You may obtain a copy of the License at

www.apache.org/licenses/LICENSE-2.0

Unless required by applicable law or agreed to in writing, software distributed under the License is distributed on an AS IS BASIS, WITHOUT WARRANTIES OR CONDITIONS OF ANY KIND, either express or implied.

See the License for the specific language governing permissions and limitations under the License.

The curl License

COPYRIGHT AND PERMISSION NOTICE

Copyright (c) 1996 - 2025, Daniel Stenberg, daniel@haxx.se, and many contributors, see the THANKS file.

All rights reserved.

Permission to use, copy, modify, and distribute this software for any purpose with or without fee is hereby granted, provided that the above copyright notice and this permission notice appear in all copies.

THE SOFTWARE IS PROVIDED "AS IS", WITHOUT WARRANTY OF ANY KIND, EXPRESS OR IMPLIED, INCLUDING BUT NOT LIMITED TO THE WARRANTIES OF MERCHANTABILITY, FITNESS FOR A PARTICULAR PURPOSE AND NONINFRINGEMENT OF THIRD PARTY RIGHTS. IN NO EVENT SHALL THE AUTHORS OR COPYRIGHT HOLDERS BE LIABLE FOR ANY CLAIM, DAMAGES OR OTHER LIABILITY, WHETHER IN AN ACTION OF CONTRACT, TORT OR OTHERWISE, ARISING FROM, OUT OF OR IN CONNECTION WITH THE SOFTWARE OR THE USE OR OTHER DEALINGS IN THE SOFTWARE.

Except as contained in this notice, the name of a copyright holder shall not be used in advertising or otherwise to promote the sale, use or other dealings in this Software without prior written authorization of the copyright holder.

=====
libc++ License
=====

The libc++ library is dual licensed under both the University of Illinois "BSD-Like" license and the MIT license.

As a user of this code you may choose to use it under either license. As a contributor, you agree to allow your code to be used under both.

Full text of the relevant licenses is included below.

=====

University of Illinois/NCSA
Open Source License

Copyright (c) 2009-2017 by the contributors listed in CREDITS.TXT

All rights reserved.

Developed by:

LLVM Team

University of Illinois at Urbana-Champaign

<http://llvm.org>

Permission is hereby granted, free of charge, to any person obtaining a copy of this software and associated documentation files (the "Software"), to deal with the Software without restriction, including without limitation the rights to use, copy, modify, merge, publish, distribute, sublicense, and/or sell copies of the Software, and to permit persons to whom the Software is furnished to do so, subject to the following conditions:

* Redistributions of source code must retain the above copyright notice, this list of conditions and the following disclaimers.

* Redistributions in binary form must reproduce the above copyright notice, this list of conditions and the following disclaimers in the documentation and/or other materials provided with the distribution.

* Neither the names of the LLVM Team, University of Illinois at Urbana-Champaign, nor the names of its contributors may be used to endorse or promote products derived from this Software without specific prior written permission.

THE SOFTWARE IS PROVIDED "AS IS", WITHOUT WARRANTY OF ANY KIND, EXPRESS OR IMPLIED, INCLUDING BUT NOT LIMITED TO THE WARRANTIES OF MERCHANTABILITY, FITNESS FOR A PARTICULAR PURPOSE AND NONINFRINGEMENT. IN NO EVENT SHALL THE CONTRIBUTORS OR COPYRIGHT HOLDERS BE LIABLE FOR ANY CLAIM, DAMAGES OR OTHER LIABILITY, WHETHER IN AN ACTION OF CONTRACT, TORT OR OTHERWISE, ARISING FROM, OUT OF OR IN CONNECTION WITH THE SOFTWARE OR THE USE OR OTHER DEALINGS WITH THE SOFTWARE.

Copyright (c) 2009-2014 by the contributors listed in CREDITS.TXT

Permission is hereby granted, free of charge, to any person obtaining a copy of this software and associated documentation files (the "Software"), to deal in the Software without restriction, including without limitation the rights to use, copy, modify, merge, publish, distribute, sublicense, and/or sell copies of the Software, and to permit persons to whom the Software is furnished to do so, subject to the following conditions:

The above copyright notice and this permission notice shall be included in all copies or substantial portions of the Software.

THE SOFTWARE IS PROVIDED "AS IS", WITHOUT WARRANTY OF ANY KIND, EXPRESS OR IMPLIED, INCLUDING BUT NOT LIMITED TO THE WARRANTIES OF MERCHANTABILITY, FITNESS FOR A PARTICULAR PURPOSE AND NONINFRINGEMENT. IN NO EVENT SHALL THE AUTHORS OR COPYRIGHT HOLDERS BE LIABLE FOR ANY CLAIM, DAMAGES OR OTHER LIABILITY, WHETHER IN AN ACTION OF CONTRACT, TORT OR OTHERWISE, ARISING FROM, OUT OF OR IN CONNECTION WITH THE SOFTWARE OR THE USE OR OTHER DEALINGS IN THE SOFTWARE.

Cautions on copyrights

Recordings you have made are for your personal enjoyment and according to copyright laws may not be used without the consent of the copyright holder.

- Music recorded from CDs, etc., is protected by the copyright laws of individual countries and by international treaties. It is the full responsibility of the person who has recorded the music to ensure that it is used legally.
- When handling music downloaded from the Internet, etc., it is the full responsibility of the person who has downloaded the music to ensure that it is used in accordance with the contract concluded with the download site.

The specifications and design of this product are subject to change without notice.

© 2025 AlphaTheta Corporation. All rights reserved.

<DRI1965-A>